



# BARN DOOR OVERSTOCK

## **Standard Track Kits**

- 1000 Series
- 3000 Series
- 5000 Series
- 6000 Series

## **Round Track Kits**

- Double Wheel
- Single Wheel

## **Split Track Kits**

- 1000 Series
- 3000 Series

## **Round Track Components**

## **Track Components**

## **Handles**

# DELANEY® FLAT TRACK KITS

## Each Flat Track Series Includes:

- Two Hangers with Quiet Bearing Wheels
- Steel Track (Pre-drilled)
- Standoffs and Lag Bolts (6'- 5ct bolts and 8'- 5ct bolts)
- Two Door Stops
- One Door T-Guide
- Anti-Jump Discs
- Bolts, Nuts, and Washers

**Weight Limit:**  
330 lb per set



## 1000 SERIES Standard

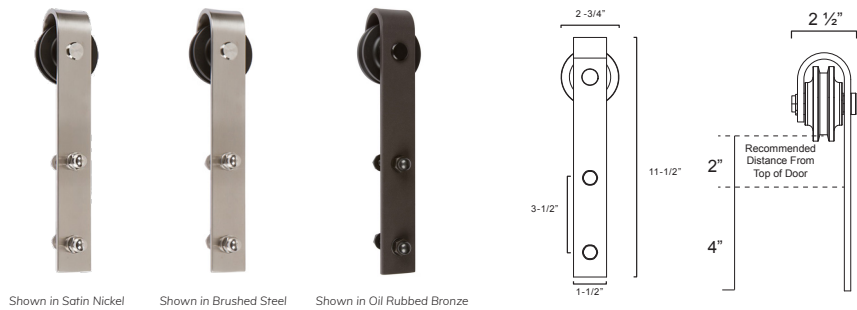

| Description                                    | WT/CTN | CTN QTY | US10B Oil Rubbed Bronze |           |          | US15 Satin Nickel |          | Brushed Steel |  |
|--|--------|---------|-------------------------|-----------|----------|-------------------|----------|---------------|--|
|  |        |         | Item No.                | Net Price | Item No. | Net Price         | Item No. | Net Price     |  |
| 1000 Series 5ft Barn Door Hardware (Standard)  | 16 lb  | 1       | Item No.                | —         | BD1052   | —                 | —        | —             |  |
|  |        |         | Net Price               |           | \$70.56  |                   |          |               |  |
| 1000 Series 6ft Barn Door Hardware (Standard)  | 16 lb  | 1       | Item No.                | BD1069    | BD1062   | BD1061            |          |               |  |
|  |        |         | Net Price               | \$75.60   | \$75.60  | \$75.60           |          |               |  |
| 1000 Series 8ft, Barn Door Hardware (Standard) | 18 lb  | 1       | Item No.                | —         | BD1082   | BD1081            |          |               |  |
|  |        |         | Net Price               |           | \$100.80 | \$64.50           |          |               |  |

## 3000 SERIES-Top Mount Standard Track

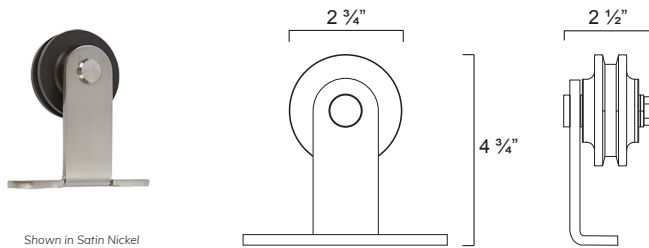

| Description                                    | WT/CTN | CTN QTY | US15 Satin Nickel |           |
|--|--------|---------|-------------------|-----------|
|  |        |         | Item No.          | Net Price |
| 3000 Series 6ft Barn Door Hardware (Standard)  | 16 lb  | 1       | Item No.          | BD3062    |
|  |        |         | Net Price         | \$132.48  |
| 3000 Series 8ft, Barn Door Hardware (Standard) | 18 lb  | 1       | Item No.          | BD3082    |
|  |        |         | Net Price         | \$160.92  |

# DELANEY® FLAT TRACK KITS

## 5000 SERIES-Wagon Wheel Standard Track



Shown in Oil Rubbed Bronze



Shown in Matte Black

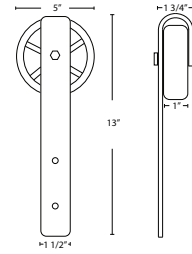

| Description                                    | WT/CTN | CTN QTY | US10B Oil Rubbed Bronze |         | US19 Matte Black |   |
|--|--------|---------|-------------------------|---------|------------------|---|
|  |        |         | Item No.                | BD5069  | —                | — |
| 5000 Series 6ft Barn Door Hardware (Standard)  | 16 lb  | 1       | Net Price               | \$70.56 |                  |   |
| 5000 Series 8ft, Barn Door Hardware (Standard) | 18 lb  | 1       | Item No.                | —       | BD5084           |   |
|  |        |         | Net Price               |         | \$130.32         |   |

## 6000 SERIES-Diamond



Shown in Satin Nickel



Shown in Brushed Steel

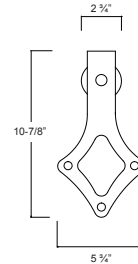

| Description                                    | WT/CTN | CTN QTY | US15 Satin Nickel |         | Brushed Steel |   |
|--|--------|---------|-------------------|---------|---------------|---|
|  |        |         | Item No.          | BD6062  | —             | — |
| 6000 Series 6ft Barn Door Hardware (Standard)  | 16 lb  | 1       | Net Price         | \$53.90 |               |   |
| 6000 Series 8ft, Barn Door Hardware (Standard) | 18 lb  | 1       | Item No.          | BD6082  | BD6081        |   |
|  |        |         | Net Price         | \$61.34 | \$82.37       |   |

## Round Track Double Wheel

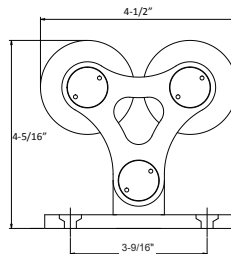

| Description   | WT/CTN | CTN QTY | Brushed Steel |          |
|---|--------|---------|---------------|----------|
|   |        |         | Item No.      | SD2081   |
| Round Sliding Door 8 FT Double Wheel Barn Door Hardware | 18 lb  | 1       | Net Price     | \$125.13 |

## Round Track Single Wheel

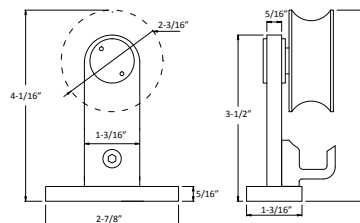

| Description   | WT/CTN | CTN QTY | Brushed Steel |          |
|---|--------|---------|---------------|----------|
|   |        |         | Item No.      | SD1081   |
| Round Sliding Door 8 FT Single Wheel Barn Door Hardware | 18 lb  | 1       | Net Price     | \$107.25 |

# DELANEY® SPLIT TRACK KITS

## Each Split Track Series Includes:

- Two Hangers with Quiet Bearing Wheels
- Two Steel Tracks (Pre-drilled)
- Standoffs and Lag Bolts (6'- 5ct bolts and 8'- 5ct bolts)
- Two Door Stops
- One Door T-Guide
- Anti-Jump Discs
- Bolts, Nuts, and Washers

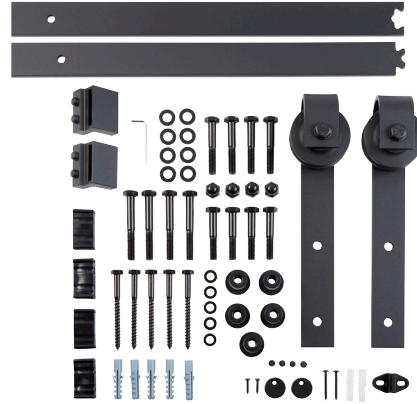

**Weight Limit:**  
330 lb per set

## 1000 SERIES Split Track

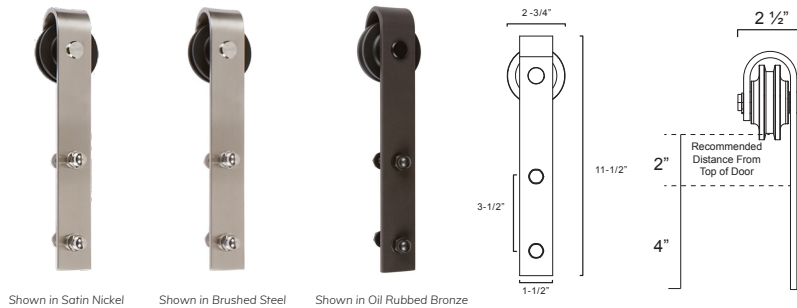





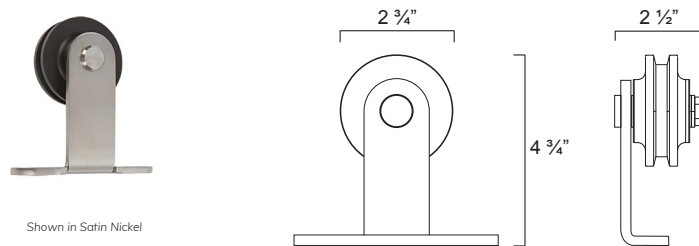
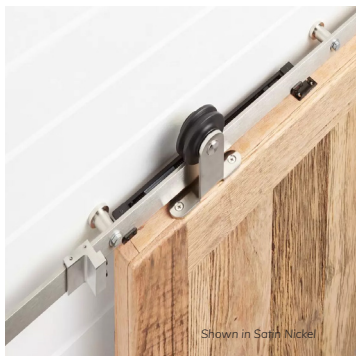

| Description                                       | WT/ CTN | CTN QTY | US10B Oil Rubbed Bronze |           |  | US15 Satin Nickel |           |  | Brushed Steel |           |  |
|---|---------|---------|-------------------------|-----------|--|-------------------|-----------|--|---------------|-----------|--|
|   |         |         | Item No.                | Net Price |  | Item No.          | Net Price |  | Item No.      | Net Price |  |
| 1000 Series 6ft Barn Door Hardware (Split Track)  | 16 lb   | 1       | BD1069S                 | \$75.60   |  | BD1062S           | \$75.60   |  | BD1061S       | \$75.60   |  |
|   |         |         |                         |           |  |                   |           |  |               |           |  |
| 1000 Series 8ft, Barn Door Hardware (Split Track) | 18 lb   | 1       | —                       |           |  | BD1082S           | \$100.80  |  | —             |           |  |
|   |         |         |                         |           |  |                   |           |  |               |           |  |

## 3000 SERIES-Top Mount Split Track







| Description                                      | WT/ CTN | CTN QTY | US15 Satin Nickel |           |  |
|--|---------|---------|-------------------|-----------|--|
|  |         |         | Item No.          | Net Price |  |
| 3000 Series 6ft Barn Door Hardware (Split Track) | 16 lb   | 1       | BD3062S           | \$132.48  |  |
|  |         |         |                   |           |  |



## ROUND TRACK KIT COMPONENTS

|   | Description  | Finish                         | Item No.         | Net Price          |
|---|--|--------------------------------|------------------|--------------------|
|  | Single Wheel Hanger Only for Round Track Only w/ Mounting Screws | Brushed Steel                  | SD1001           | \$15.13            |
|  | Double Wheel Hanger Only for Round Track Only w/ Mounting Screws | Brushed Steel                  | SD2001           | \$34.83            |
|  | Sliding Door Stops for Round Track (Pair)                        | Brushed Steel                  | SD0001           | \$7.23             |
|  | Round Track Mounting Plates and Screws                           | Brushed Steel                  | SD0002           | \$3.87             |
|  | Round Track Soft Closer  | Brushed Steel                  | SD0020           | \$9.68             |
|  | 6' Round Track Only<br>8' Round Track Only                       | Brushed Steel<br>Brushed Steel | SD1161<br>SD1181 | \$56.89<br>\$70.06 |

## FLAT TRACK KIT COMPONENTS

|   | Description                                      | Finish            | Item No. | Net Price |
|---|--|-------------------|----------|-----------|
|  | 1000 Series Hanger Only w/ Mounting Screws       | Oil Rubbed Bronze | BD1009   | \$24.84   |
|  | 5000 Series Hanger Only w/ Mounting Screws       | Oil Rubbed Bronze | BD5009   | \$12.20   |
|  | 6000 Series Hanger Only w/ Mounting Screws       | Matte Black       | BD6004   | \$11.00   |
|  | 100 Series "Mini" Hanger Only w/ Mounting Screws | Matte Black       | BDM1004  | \$4.73    |
|  | Barn Door Lag Bolt and Spacer- 1-3/8" Standard   | Black             | BD0069   | \$8.64    |

## BARN DOOR HANDLES

|   | Description                                       | Finish            | Item No. | Net Price |
|---|---|-------------------|----------|-----------|
|  | Barn Door Combo Flush with Round Handle-12"       | Brushed Steel     | BD0801   | \$18.72   |
|  | Barn Door Pull Handle Single-Sided Round- 15-3/4" | Oil Rubbed Bronze | BD0159   | \$28.80   |